

IRH PP€À• @€0ZD!•V4@ öcD 1• @0

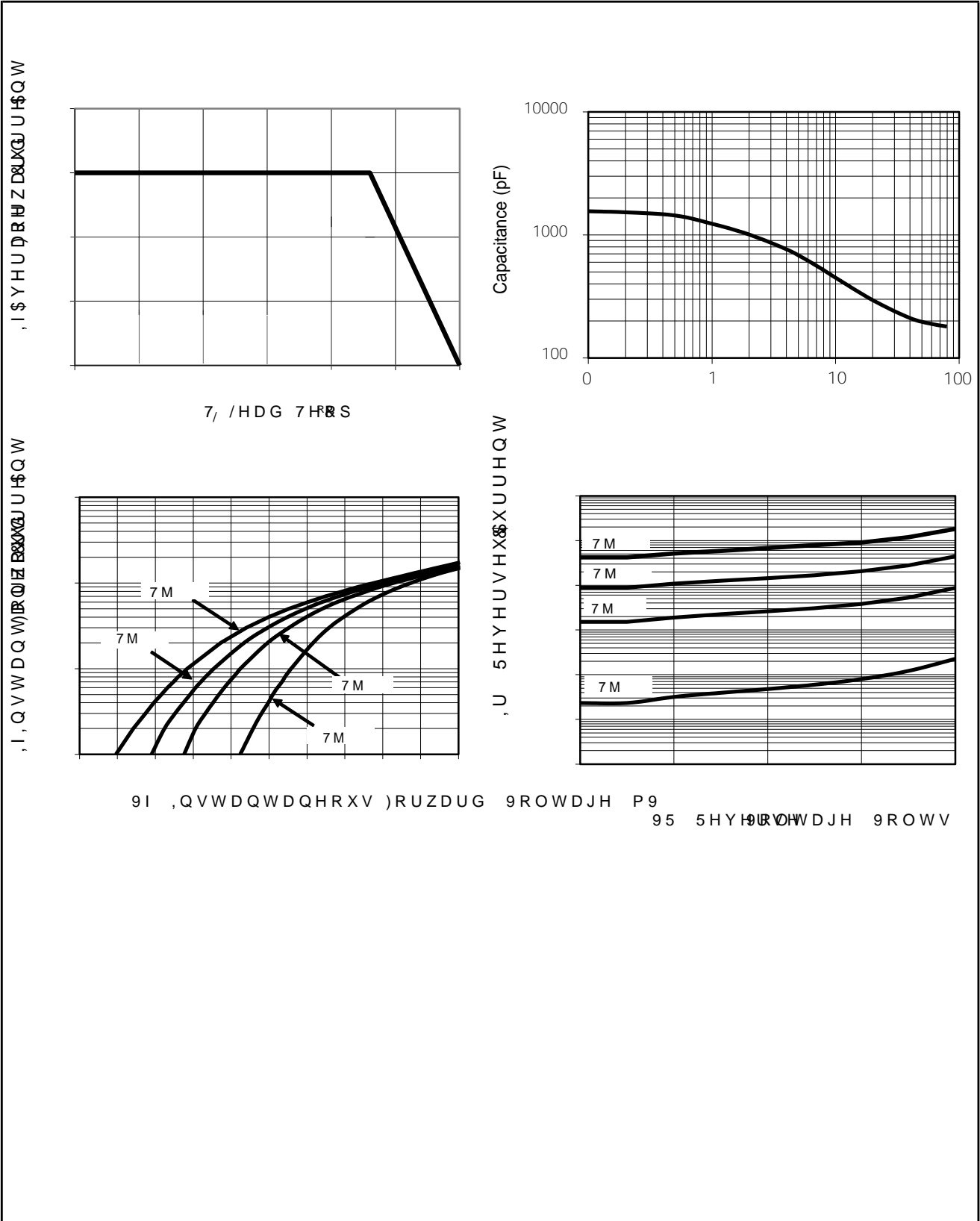

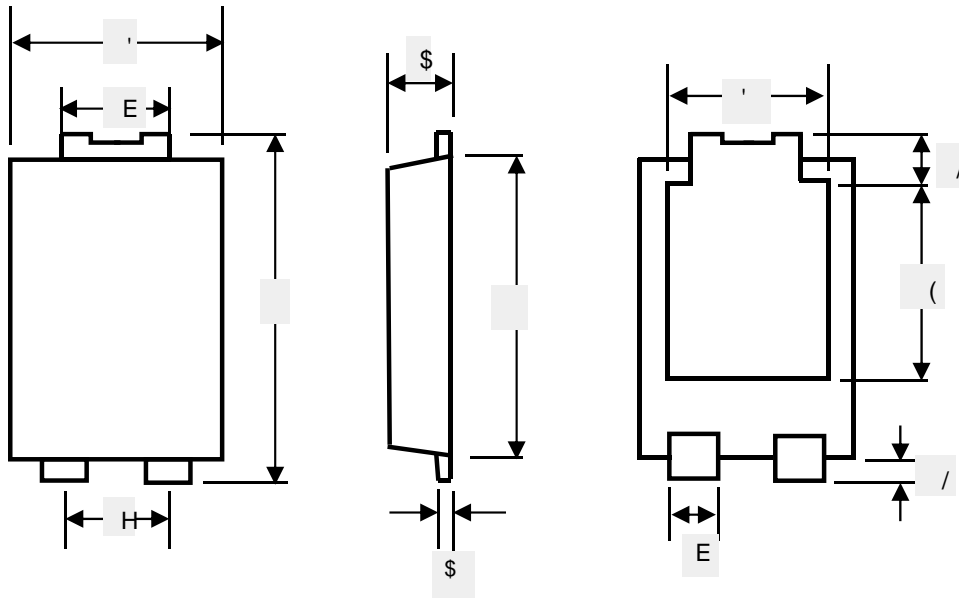

81,7		\$	\$	E	E	'	'	(	(	(	/	/
PP	PD[											
	PLQ											
PLO	PD[											
	PLQ											

72

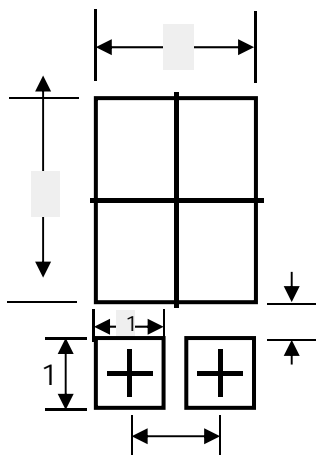

81,7		&	*	;	;	M	M%
PP	PLQ					(" -	%" (
PLO	PLQ					%&" -% )	)"%&

3URGXFW PRGHO 5HHO'PHQVLRQV  
 WR DV /  
 83' & LQIRUFDWLRQ

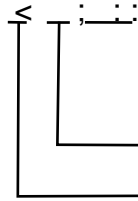
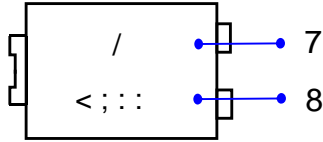

:: :HHN FRGH WR

; ,QWHUQDO LGHQWLILFDWLRQ

< <HDU FRGH H[

5HHO' LPHQVLRQV

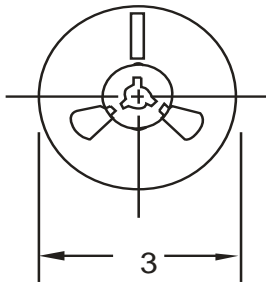

,QVLGH %R[

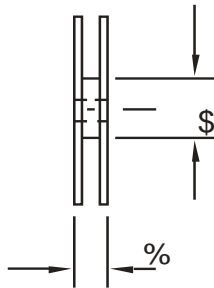

2XWVLGH %R[

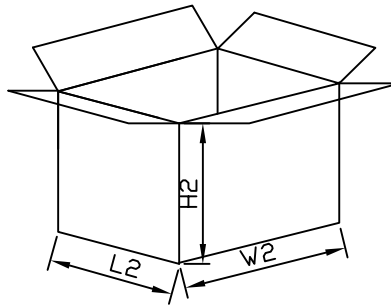
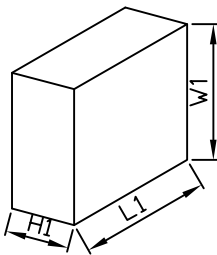

12	81,7	5HHO'PHQVLRQV			,QVLGH %R[			2XWVLGH %R[		
6L]H	PP	&	\$	%	/	:	+	/	:	+
47<	3&6	6PDOOHVW SDFNDJH			3&6 UHHO			3&6 UHHO		
1RWH		7ROHUDQFHP" PP			PP" PP			PP" PP		