

7UHQFK 026 %DUULHU 6FKRWWN\ 5H

763 9 63
TO-277

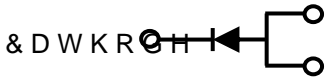

&DWKRCH \$QRGH

)HDWXUHV

‡ \$GYDQWUHQFK WHFKQRORJ\ \\
‡ /RZRUZVROWDJH GURS
‡ /RZRZURVVHV
‡ +LJHILFLHQF\ RSHUDWLRQ
‡ /HDGH)HLQLVK &RPSOLDQW

\$SSOLFDFWLRQV

‡ '& '& &RQYHUWHUV
‡ \$\$ '&\$GDSWRUV
‡ 6ZLWFKRZHXSSOLHV
‡)UHHZKHHLRGLJ

0D[LPXP UDWLQJV DQG HOHFWULFDJ& FXODDWHVHUQRWHIGV

3DUDPHWHU		6\PERO	/LPLW	8QLW
0D[LPXP SHSHVSHUNYHYURQWDJH		9550		9
0D[LPXPYHURJHZDUG UFKXWHLQWG		,) \$9		\$
3HDN IRVZDUEBUUHQW VLKDDHQZDYH VXSHULP&DCHVRS&GLRGH		,) 60	0	\$
2SHUDMXLQDQCRQWRUDJH WDESHUDW XOH 767			WR	f&
7\SLFDO WKHUPDO UHVLVWDQFH SHU		GLS&H	ORXQWHG RQ)5	3&f% :
,QVWDQWDQHRROWRUJZDUG SHGLRGH	,) \$	7- f&	7<3	0\$;
	,) \$	7- f&		
	,) \$	7- f&		8
	,) \$	7- f&		
,QVWDQWDQHRXVUSHOMRQWH UDWHYHYURQWDJH		7- f&		X\$
		7- f&	5	P\$

1RWHV

3XOVH WHVVSXOVH ZLGWK GXW\ F\FOH

3XOVH WHVW 3XOPH ZLGWK 0

5\$7,1*6 \$1' &+\$5\$&7(5,67,&6 &7859(6f& XQOHVQRWKBZULYH

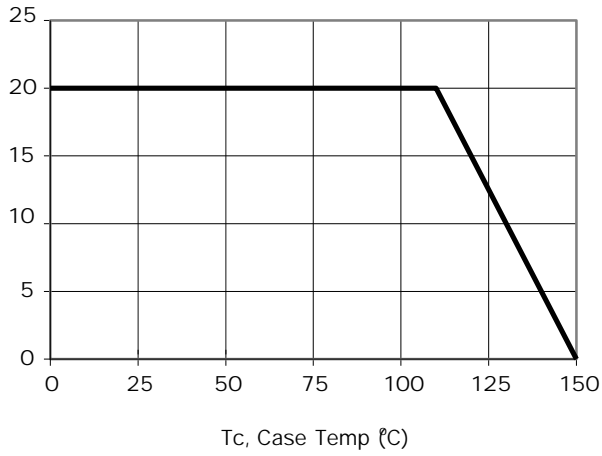

& D S D F L V S D Q F H

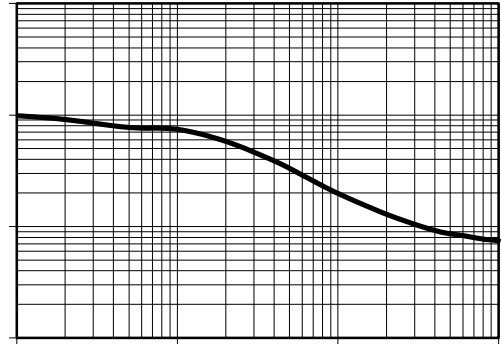

Reverse Voltage (V)

, I, Q V W D Q W D Q H R X V) R U Z D U G

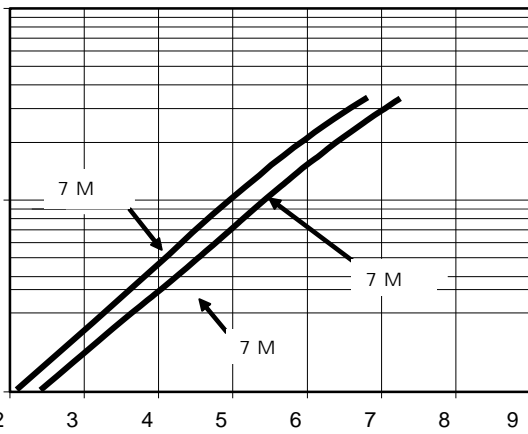

9 I , Q V W D Q W D Q H R X V) R U Z D U G

, U 5 H Y H U V W X & X U U H Q W

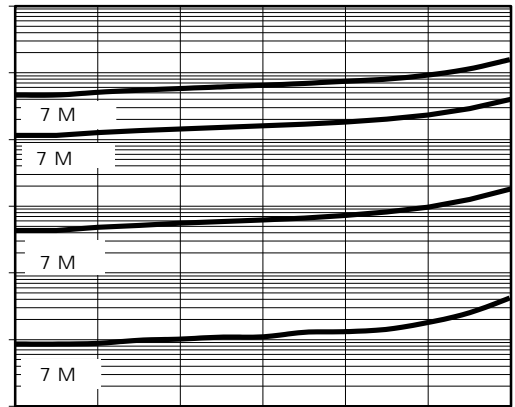

9 R O W D J H 9 5 9 5 H Y H U V W X & X U U H Q W 9 R O W D J H 9 R O W V

3 \$ & . \$ * (2 8 7 / , 1 (' , 0 (1 6 , 2 1 6

TO-277

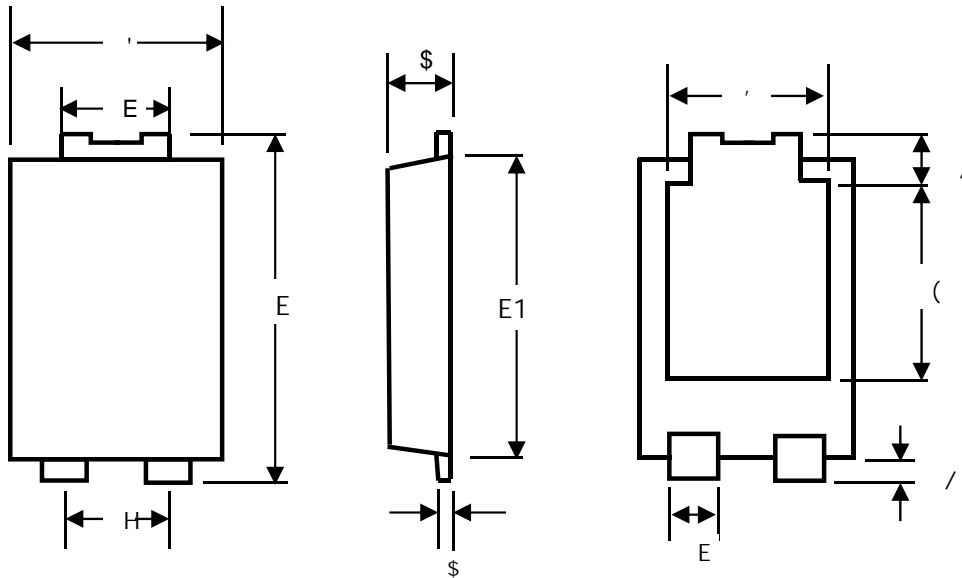

7 2 M D

T		\$	E	E	'	'	(((/	/
PP	PDI										
	PLQ										
PLO	PDI										
	PLQ										

7 2 6 X J J H V W D H G \ R X W

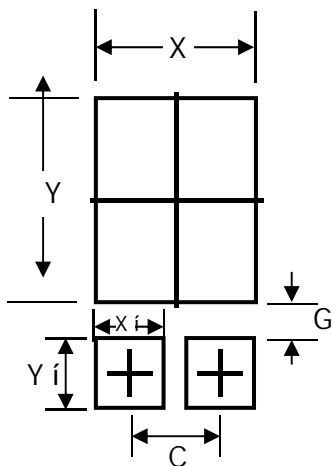

8 1 , 7	&	*	;	;	<	<
PP	PLQ					
PLO	PLQ					

0DUNLQJ ,QIRUPDWLRQ

73URGXFW PRGHO 75BIH0UH0 3
WR DV 9

83' & LQIRUPDWLRQ

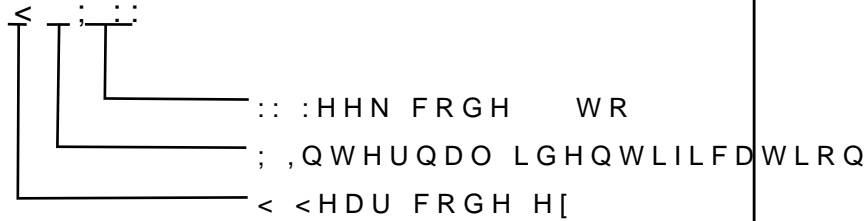
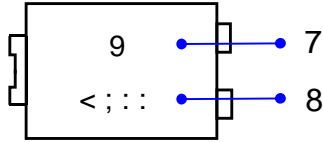

3DFNDJLQJ ,QIRUPDWLRQ

5HHO 'LPHQVLRQV

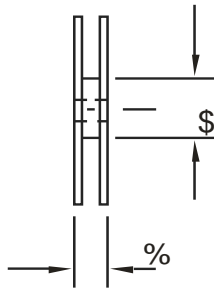
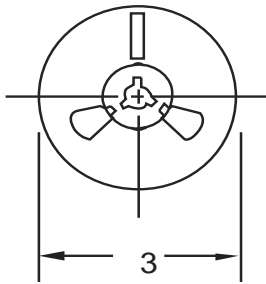

,QVLGH %R[

2XWVLGH %R[

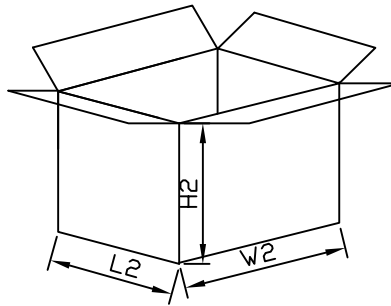
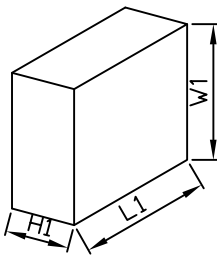

3DFNDJLQJ ,QIRUPDWLRQ

12	81,7	5HHO'PHQVLRQV			,QVLGH %R[2XWVLGH %R[
		&	\$	%	/	:	+	/	:	+
6L]H	PP									
47<	3&6	6PDOOHVW SDFNDJH			3&6 UHHO			3&6 & 6 JHFOUWLRQ		
1RWH		7ROHUDQFH PP" PP			PP" PP			PP" PP		