

7UHQFK 026 %DUULHU 6FKRWWN\ 5H

**Features**

- Advanced trench technology
- Low forward voltage drop
- Low power losses
- High efficiency operation
- Lead Free Finish, RoHS Compliant

**Applications**

- DC/DC Converters
- AC/DC Adaptors
- Switching Power Supplies
- Freewheeling Diodes

**Maximum ratings and electrical characteristics (TJ = 25°C unless otherwise noted)**

Parameter	Symbol	Limit	Unit
Maximum repetitive peak reverse voltage	VRRM		V
Maximum average forward rectified current	IF(AV)		A
Peak forward surge current 8.3 ms single half sine- wave superimposed on rated load per diode	IFSM	60	A
Operating junction and storage temperature range	TJ, TSTG	WR	°C
7\SLFDO WKHUPDO UHVLVWDQFH SHU GLSHG 10RXQWHG RQ )5	3&CAV		
Instantaneous forward voltage per diode	VF(1)	7 < 3	0 \$ ;
		IF= A TJ=25°C	
		IF= A TJ=125°C	V
Instantaneous reverse current per diode at rated reverse voltage	IR(2)	TJ=25°C	X \$
		TJ=125°C	mA

Notes:

3XOVH WHVW 3XOVH ZLGWK GXW\ F\FOH  
 3XOVH WHVW 3XOVH ZLGWK 0

**RATINGS AND CHARACTERISTICS CURVES** (TA = 25 C unless otherwise noted)

If, Average Forward Current(A)

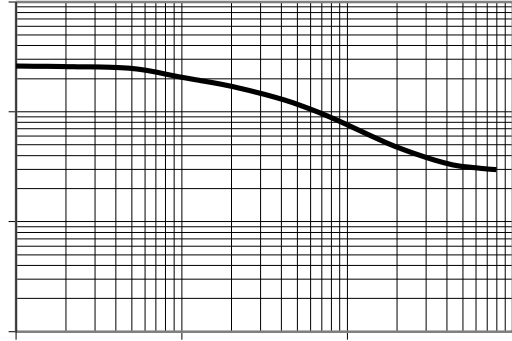
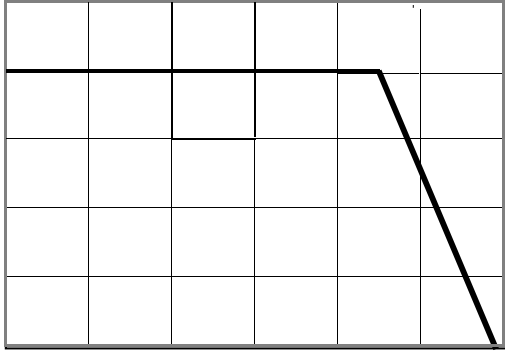

If, Instantaneous Forward Current (A)

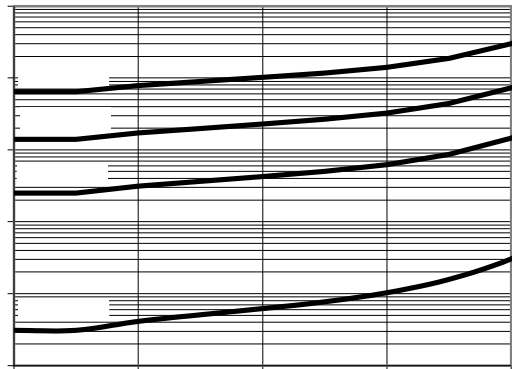
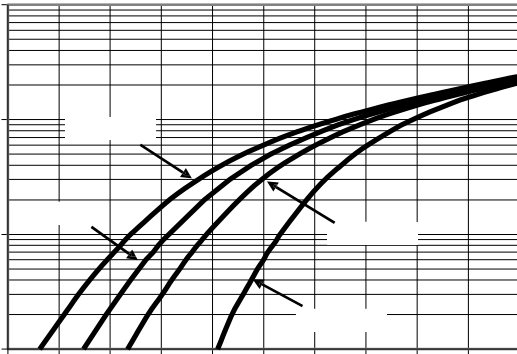

## PACKAGE OUTLINE DIMENSIONS

### TO-277

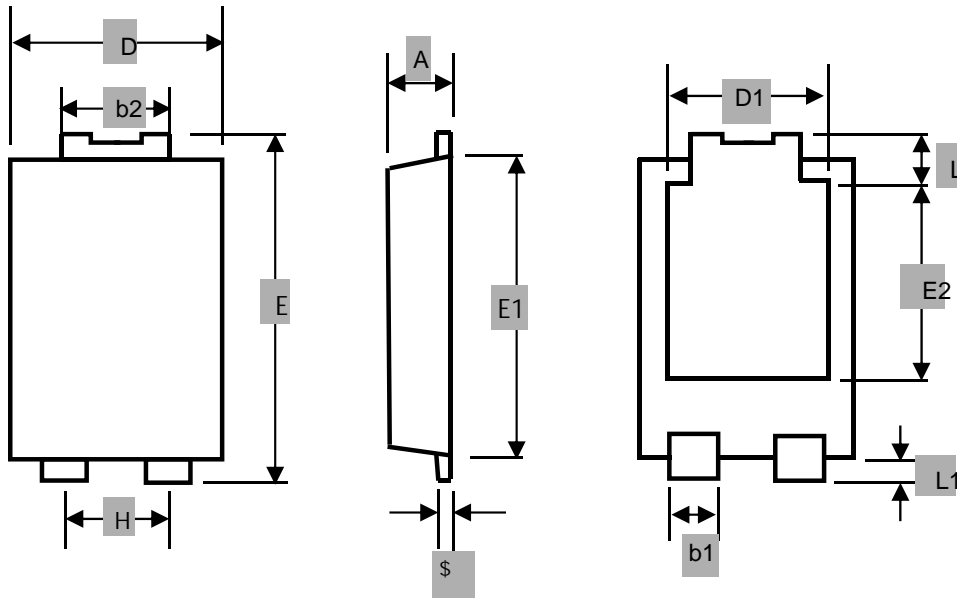

### TO-277 Mechanical Data

UNIT	A	2	1	D	D
------	---	---	---	---	---

### TO-277 Suggested Pad Layout

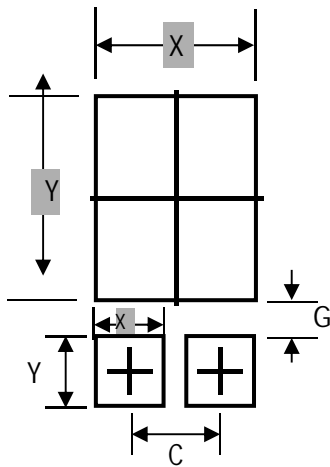

UNIT			G			
mm	min	.80	0.0	34		4.
mil	min	78.86	35.43	35.43		55.

**Marking Information**

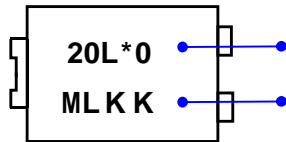

Product model :TSP20L60

Referred to as 20L60

PDC information

Y X WW

WW:Week code(01 to 53)

X:Internal identification code

Y:Year code(ex:0=2020)

**Packaging Information**

1.Reel Dimensions

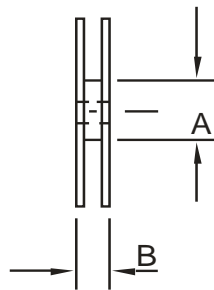
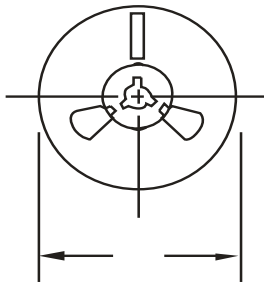

2. Inside Box

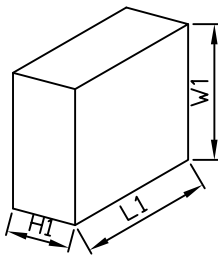

3. Outside Box

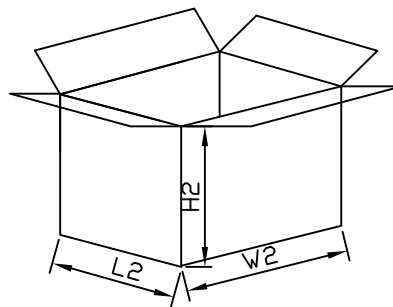

**Packaging Information**

NO	UNIT	Reel Dimensions			Inside Box			Outside Box		
			A	B	L1	W1	H1	L2	W2	H2
Size	mm	330	70	15	335	335	43	360	360	360
QTY	PCS	Smallest package,5000PCS/reel			10,000PCS,2 reel in total			80,000PCS/carton,8 in total boxes		
Note	Tolerance 20mm,±3mm; 21-100mm,±5mm; 101-500mm,±10mm									